

IAN SOFAS

Features

- Made in North Carolina from U.S. and imported materials
- Meets or exceeds ANSI/BIFMA X5.1-2012 standards for commercial use
- 5 year warranty



Ian 90" sofa in Orla grey

Ian sofa collection

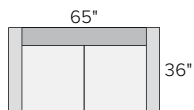

65" loveseat

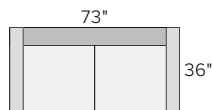

73" sofa

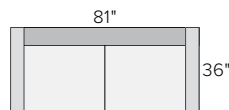

81" sofa

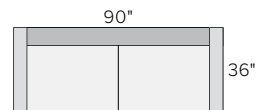

90" sofa

IAN CHAIR AND OTTOMANS

Features

- Made in North Carolina from U.S. and imported materials
- Meets or exceeds ANSI/BIFMA X5.1-2012 standards for commercial use
- 5 year warranty



Ian chair and 28"x21" ottoman*
in Orla grey

Ian chair and ottoman collection

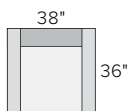

chair



28"x21"
ottoman*

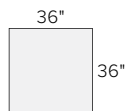

36" square
ottoman*

IAN SOFAS WITH CHAISE

Features

- Made in North Carolina from U.S. and imported materials
- Meets or exceeds ANSI/BIFMA X5.1-2012 standards for commercial use
- 5 year warranty



Ian 108" sofa with left-arm chaise in Orla grey

Ian sofa with chaise collection

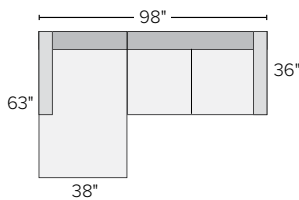

98" sofa with left-arm chaise

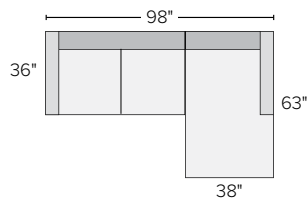

98" sofa with right-arm chaise

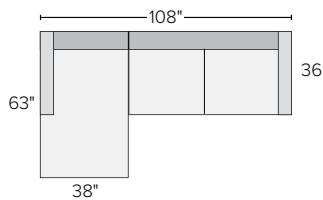

108" sofa with left-arm chaise

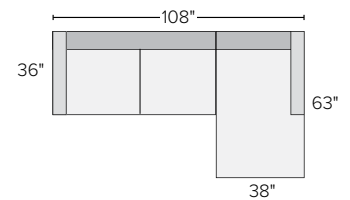

108" sofa with right-arm chaise

IAN SECTIONAL PIECES

Features

- Made in North Carolina from U.S. and imported materials
- Meets or exceeds ANSI/BIFMA X5.1-2012 standards for commercial use
- 5 year warranty



Ian 137"x106" four-piece sectional with left-arm chaise in in Orla grey

Ian sectional pieces collection

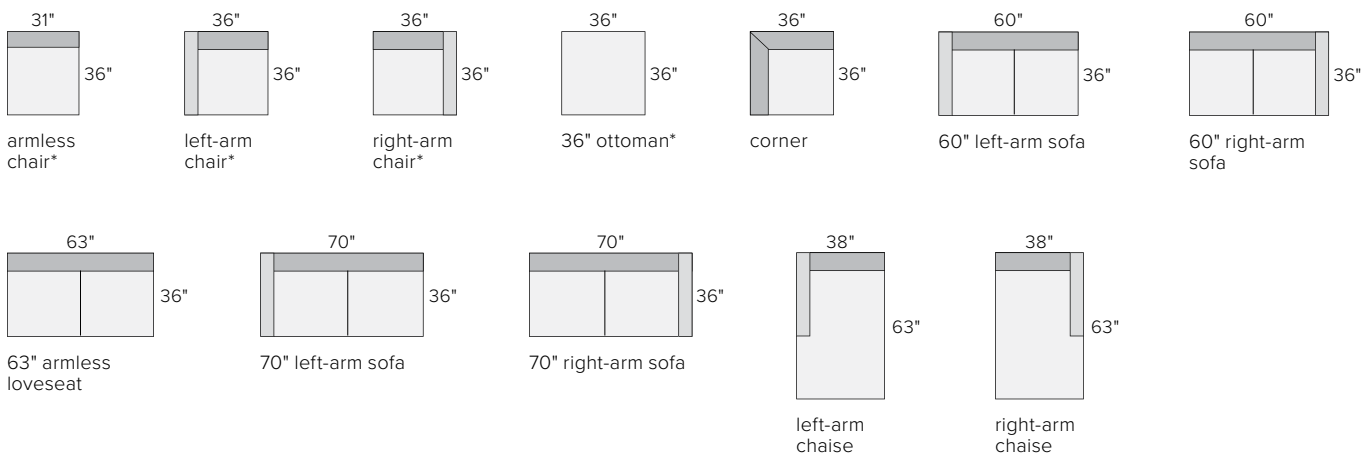

*allow extra time

IAN SECTIONALS

Features

- Made in North Carolina from U.S. and imported materials
- Meets or exceeds ANSI/BIFMA X5.1-2012 standards for commercial use
- 5 year warranty



Ian 137"x106" four-piece sectional with left-arm chaise in in Orla grey

Ian sectional collection

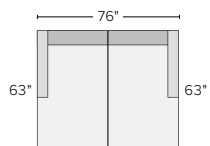

76"x63" two-piece sectional with double chaise

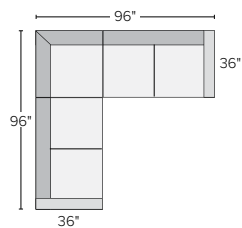

96"x96" three-piece sectional

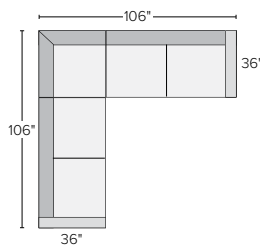

106"x106" three-piece sectional

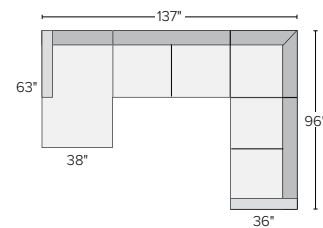

137"x96" four-piece sectional with left- or right-arm chaise

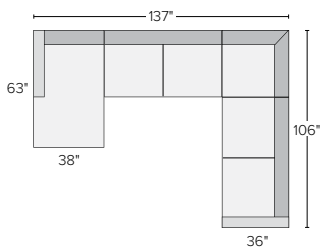

137"x106" four-piece sectional with left- or right-arm chaise

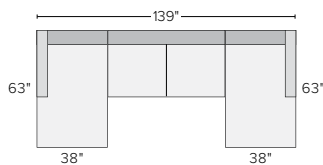

139"x63" three-piece U-shaped sectional

IAN

Features

- Free swatches available
- Custom order in any Business Interiors approved leather or ACT® contract grade Room & Board fabric
- COM available upon request; ask us for details

ACT® contract grade stocked fabrics



Tatum mink

PRICE GROUP: 2
 APPLICATION: indoor upholstery
 CONTENT: 64% polyester, 36% acrylic boucle
 FEATURES: family/dog friendly, performance
 CLEANING CODE: S, solvent based
 WOVEN IN: United States
 CERTIFICATIONS: ACT® contract grade

BACKING: acrylic latex
 STAIN-REPELLENT FINISH: no
 FABRIC DIRECTION: railroaded
 FLAMMABILITY: passes CA TB 117-2013 Sect. 1
 CROCKING: wet 3, dry 4
 COLORFASTNESS: 4
 PILLING: 4
 ABRASION: 50,000 Wyzenbeek double rubs
 ACT®PERFORMANCE:

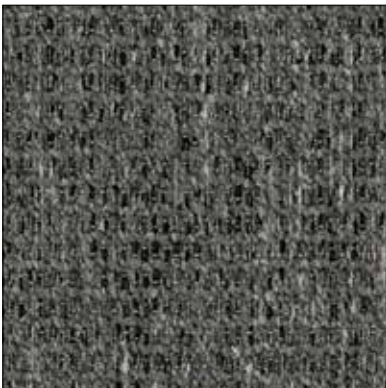
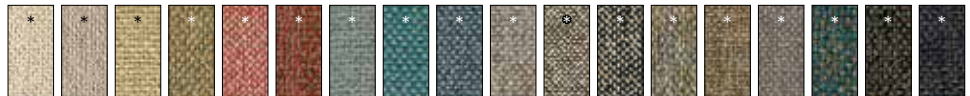

Orla grey

PRICE GROUP: 1
 APPLICATION: indoor upholstery
 CONTENT: 75% polypropylene, 25% polyester boucle
 FEATURES: family friendly, performance
 CLEANING CODE: SW, solvent or water based
 WOVEN IN: United States

CERTIFICATIONS: ACT® contract grade
 BACKING: acrylic
 STAIN-REPELLENT FINISH: no
 FABRIC DIRECTION: railroaded
 FLAMMABILITY: passes CA TB 117-2013 Sect. 1
 CROCKING: wet 5, dry 5
 COLORFASTNESS: 4
 PILLING: 5
 ABRASION: 50,000 Wyzenbeek double rubs
 ACT® PERFORMANCE:

